

Article number: 3901250050300

Description: Worm gear with solid input shaft
VF 250V-50-HS

Measures

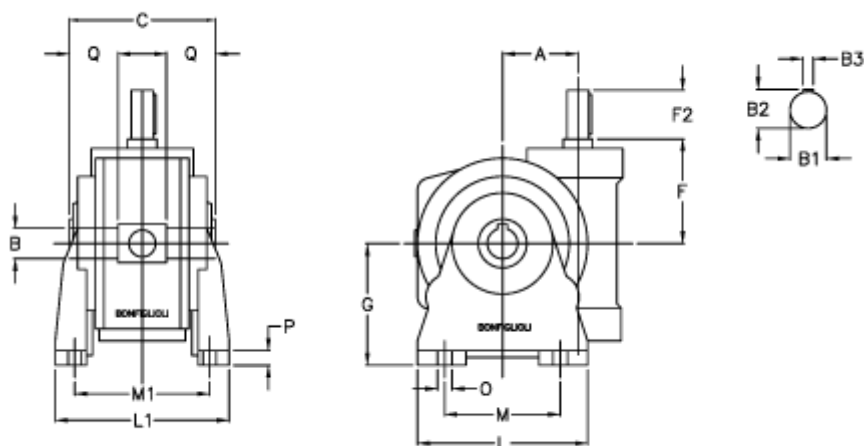

a	= 250.0	F2 = 110	Q = 85.0
B	= 110	g = 380	
B1	= 55	L = 520	
B2	= 59.0	L1 = 380	
B3	= 16	m = 400	
C	= 320	M1 = 310.0	
Description	= VF 250V-xx-HS	O = 33.0	
F	= 276.0	P = 30	